



Model Number

LGM25 Serie

Light grid

with fixed cable with 4-pin, M12 x 1 connector, and fixed cable with 8-pin, M12 x 1, connector

Features

- Measuring automation light grid with switching output
- Optical resolution 25 mm
- Super-fast object detection, even with 3-way beam crossover
- Object identification using integrated object recognition
- IO-link interface for service and process data
- Temperature range to -30 °C
- Output of a measured value, can be selected from a number of measuring functions

Product information

Automation light grids in the LGM Series are designed to measure small to large objects. The slimline light grids are modular in design and are available with various beam gaps and field heights. The entire signal evaluation process is carried out within the device. The lightweight systems can be integrated elegantly into their surroundings, from both a technical and a visual perspective. As a result, machines and plants operating in temperature ranges between -30 °C ... +60 °C can be designed to more compact dimensions.

Dimensions

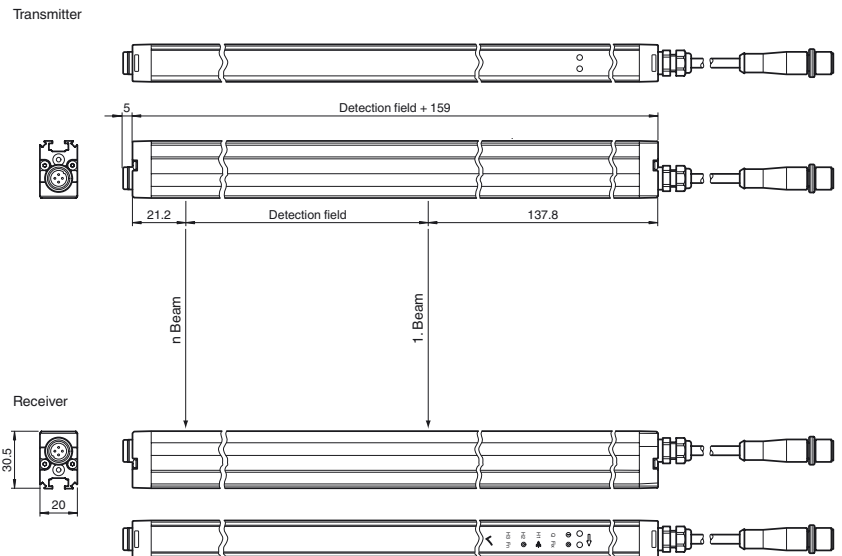

Electrical connection

Transmitter

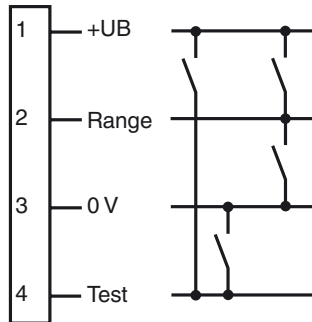

Receiver

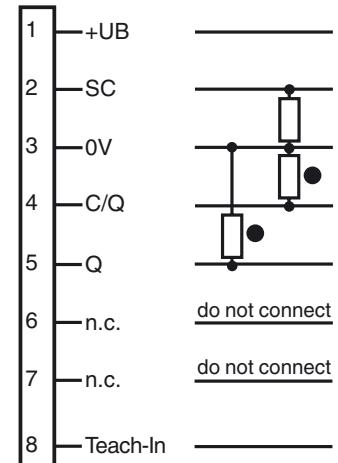

Pinout

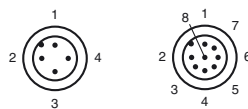

Indicators/operating means

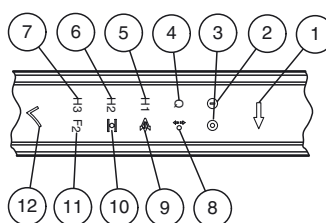

1	Menu button	yellow	7	not used	yellow
2	Operating indicator	green	8	Object floating	yellow
3	Status display	yellow	9	Crossing	yellow
4	Q object	yellow	10	Peripheral beam tolerance	yellow
5	not used	yellow	11	2nd level	yellow
6	not used	yellow	12	OK button	yellow

2nd level: Beam collimation, inverse mode, light-on/dark-on switching, reset factory setting, signal tracking

Technical data**General specifications**

Effective detection range	Standard : 0.3 ... 6 m
Threshold detection range	7.5 m
Light source	IREL
Light type	modulated infrared light , 850 nm
Field height	see Table 1, max. 3200 mm
Beam crossover	Factory setting: three beam crossing, deactivateable
Beam blanking	adjustable max. 2 fixed suppressible beam areas (blanking)
Beam spacing	25 mm
Number of beams	see Table 1, max. 129
Operating mode	Emitter: Emitter power adjustable in two ranges
Optical resolution	without beam crossover: 25 mm with beam crossover: 12.5 mm with in 25% and 75% of the range
Angle of divergence	10 °
Ambient light limit	> 50000 Lux (if external light source is outside the opening angle)

Functional safety related parameters

MTTF _d	34 a
Mission Time (T _M)	20 a
Diagnostic Coverage (DC)	60 %

Indicators/operating means

Operation indicator	LED green: constantly on - power-on double pulse flashing (0.8 Hz) - undervoltage flashing (4 Hz) - short circuit flashing with short interruptions (1 Hz) - IO-Link mode
Status indicator	Emitter: LED yellow constantly on - high emitter power constantly off - low emitter power flashing (8 Hz) - error message Receiver: LED yellow: constantly on - object detected constantly off - no object detected flashing (4 Hz) - below stability control limit flashing (8 Hz) - error message
Control elements	Receiver: 2 touch buttons for programming

Electrical specifications

Operating voltage	U _B	18 ... 30 V DC
Ripple		10 %
No-load supply current	I ₀	Emitter ≤: 50 mA Receiver: ≤ 150 mA (without outputs)
Time delay before availability	t _v	see Table 1, max. 2.3 s

Interface

Interface type	IO-Link (pin 4)
IO-Link Revision	1.0
COM-Mode	COM 2 (38.4 kBaud)
Min. cycle time	2.3 ms
Process data width	16 bit
SIO mode support	yes
Device ID	1050369 ... 1050400 (0x100701 ... 0x100720)

Input

Test input	Emitter switch-off with +UB or 0 V at pin 4 (emitter)
Function input	Range input activation from 1.6 m with +UB or 0 V on pin 2 (emitter) Teach-In input for parameterization on pin 8 (receiver)

Output

Pre-fault indication output	Stability Control (SC) 1 PNP, short-circuit protected, reverse polarity protected on pin 2 (receiver)	
Switching type	Factory setting: dark on , Switchable to light-on mode	
Signal output	Command interface: Pin 4 IO-Link interface C or used as switching output Q; 1 short-circuit proof reverse polarity protected push-pull output (receiver) Switch output: Pin 5 switching output Q; 1 short-circuit proof reverse polarity protected push-pull output (receiver) synchronized with pin 4	
Switching threshold	Factory setting: The signal tracking for the threshold value is deactivated, increasing the optical resolution by a maximum of 4 mm; switchable to active signal tracking	
Switching voltage	max. 30 V DC	
Switching current	max. 100 mA	
Voltage drop	U _d	≤ 2 V DC
Switching frequency	f	see Table 1, max. 135 Hz
Response time		see Table 1, max. 12 ms
Timer function		Off-delay programmable from 0 ... 1.25 s in 5 ms steps (adjustment via IO-Link only)

Ambient conditions

Ambient temperature	-30 ... 60 °C (-22 ... 140 °F)
---------------------	--------------------------------

Accessories**OMH-LGS-01**

Attachment aid for light grid series LGS/LGM

OMH-SLCT-06

Swivel Bracket

V19-G-EMV-BK0,3M-PVC-V19-G

Double-ended cordset, M12 to M12, with EMC filter, 8-pin, PVC cable

OMH-SLCT-01

Quick clamp and adjustment system

OMH-SLCT-03

Mounting bracket including adjustment

OMH-SLCT-05

Mounting bracket including adjustment

OMH-SLCT-04

Mounting bracket including adjustment (with loose bearing)

AA SLCT-01

Profile alignment aid; simplified alignment of the SLCS and SLCT safety light curtains

V1-G-BK2M-PUR-U

Female cordset, M12, 4-pin, PUR cable

V1-G-BK5M-PUR-U

Female cordset, M12, 4-pin, PUR cable

V1-G-BK10M-PUR-U

Female cordset, M12, 4-pin, PUR cable

V1-G-BK15M-PUR-U

Female cordset, M12, 4-pin, PUR cable

V19-G-BK10M-PUR-IEC

Female cordset, M12, 8-pin, PUR-cable

V19-G-BK2M-PUR-IEC

Female cordset, M12, 8-pin, PUR-cable

V19-G-BK5M-PUR-IEC

Female cordset, M12, 8-pin, PUR-cable

V19-G-BK2M-PUR-U-V1-G

Connection cable, M12 to M12, 8/4-pin, PUR cable

IO-Link-Master02-USB

IO-Link master, supply via USB port or separate power supply, LED indicators, M12 plug for sensor connection

IO-Link-Master-USB DTM

Communication DTM for use of IO-Link-Master

PACTware 4.1

FDT Framework

IODD Interpreter DTM

Software for the integration of IODDs in a frame application (e. g. PACTware)

LGM-Serie IODD

IODD for communication with LGM-IO-Link sensors

LGM-Serie DTM

DTM for communication with LGM sensors

Storage temperature	-30 ... 70 °C (-22 ... 158 °F)
Mechanical specifications	
Housing width	20 mm
Housing depth	30.5 mm
Housing length L	see Table 1, max. 3360 mm
Degree of protection	IP67
Connection	Emitter: 200 mm connecting cable with 4-pin, M12x1 connector Receiver: 200 mm connecting cable with 8-pin, M12 x 1 connector Cable cross section min. 0.25 mm ² Max. cable length 30 m
Material	
Housing	extruded aluminum section , Silver anodized
Optical face	Plastic pane , Polycarbonate
Mass	see Table 1, max. 1750 g (per profile)
Compliance with standards and directives	
Directive conformity	
EMC Directive 2004/108/EC	EN 60947-5-2:2007
Standard conformity	
Product standard	EN 60947-5-2:2007 IEC 60947-5-2:2007

Approvals and certificates	
Protection class	III (IEC 61140:2009)
UL approval	cULus Listed
CCC approval	CCC approval / marking not required for products rated ≤36 V

Operating principle

The light grid comprises a transmitter unit and a receiver unit; the monitored surface is located between these units. The switching command and measurement of the object is triggered when an object enters or is already present in the monitoring field.

The system's modular construction allows even the most diverse gaps between light beams to be implemented, enabling light grids in the LGM Series to be used to optimum effect and tailored to the specific application in question.

The system is programmed via the integrated touch field or via the IO-Link interface. Output of the analog measured value is included in the IO-Link protocol. Users can choose from a vast selection of integrated measurement protocols. The most important measurement protocols are:

- Lowest position of the object
- Highest position of the object
- Height of the object
- Height of the object as the total height of all partial objects
- Height of the largest partial object
- Mid-position of the largest partial object
- Lowest position of the largest partial object
- Highest position of the largest partial object
- ...

Curves/Diagrams

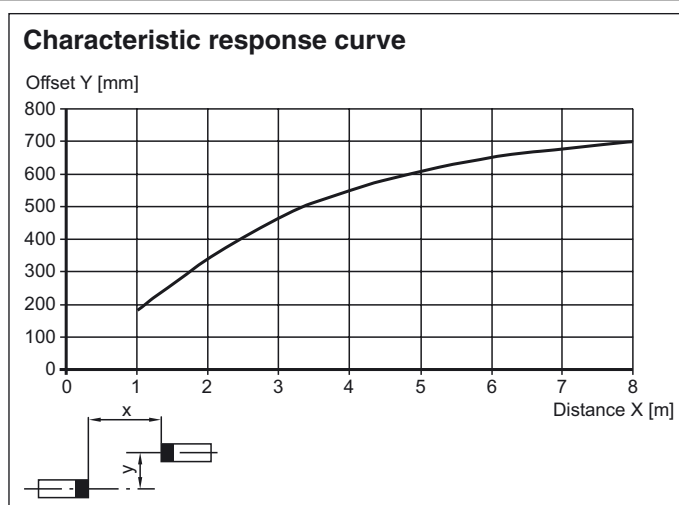

Additional Information

Table 1:

Release date: 2017-07-20 10:26 Date of issue: 2017-07-20 251333_eng.xml

Refer to "General Notes Relating to Pepperl+Fuchs Product Information".

Pepperl+Fuchs Group
www.pepperl-fuchs.com

USA: +1 330 486 0001
fa-info@us.pepperl-fuchs.com

Germany: +49 621 776 4411
fa-info@de.pepperl-fuchs.com

Singapore: +65 6779 9091
fa-info@sg.pepperl-fuchs.com

Switch-on delay, maximum switching frequency, and maximum time delay before availability:

Field height [mm]	Switch-on delay Q [ms] Without object parameterization		Switch-on delay Q [ms] - With object parameterization - Updated measured value		Maximum switching frequency [Hz]	Maximum time delay before availability t_v [s]
	typ.	max.	typ.	max.		
100	2	4	5	6	134	0.8
200	3	5	5	7	125	0.9
300	3	5	5	7	118	0.9
400	3	5	5	8	112	0.9
500	3	5	6	8	106	1.0
600	3	5	6	9	101	1.0
700	3	6	6	9	96	1.1
800	3	6	6	10	92	1.1
900	3	6	7	10	88	1.2
1000	4	6	7	11	84	1.2
1100	4	7	7	11	81	1.3
1200	4	7	7	12	78	1.3
1300	4	7	8	12	75	1.4
1400	4	7	8	13	72	1.4
1500	4	8	8	13	70	1.5
1600	4	8	8	14	67	1.5
1700	4	8	9	14	65	1.6
1800	5	8	9	15	63	1.6
1900	5	9	9	15	61	1.7
2000	5	9	9	16	60	1.7
2100	5	9	10	16	58	1.8
2200	5	9	10	17	56	1.8
2300	5	10	10	17	55	1.9
2400	5	10	10	18	53	1.9
2500	5	10	11	18	52	1.9
2600	6	10	11	19	51	2.0
2700	6	11	11	19	49	2.0
2800	6	11	11	20	48	2.1
2900	6	11	12	20	47	2.1
3000	6	11	12	21	46	2.2
3100	6	12	12	21	45	2.2
3200	6	12	12	22	44	2.3

Number of beams, housing length, and weight:

Field height [mm]	Number of beams	Overall length of the transmitter/receiver unit [mm]	Weight of transmitter/receiver unit [g]
100	5	260	200
200	9	360	250
300	13	460	300
400	17	560	350
500	21	660	400
600	25	760	450
700	29	860	500
800	33	960	550
900	37	1060	600
1000	41	1160	650
1100	45	1260	700
1200	49	1360	750
1300	53	1460	800
1400	57	1560	850
1500	61	1660	900
1600	65	1760	950
1700	69	1860	1000
1800	73	1960	1050
1900	77	2060	1100
2000	81	2160	1150
2100	85	2260	1200
2200	89	2360	1250
2300	93	2460	1300

Release date: 2017-07-20 10:26 Date of issue: 2017-07-20 251333_eng.xml

Field height [mm]	Number of beams	Overall length of the transmitter/receiver unit [mm]	Weight of transmitter/receiver unit [g]
2400	97	2560	1350
2500	101	2660	1400
2600	105	2760	1450
2700	109	2860	1500
2800	113	2960	1550
2900	117	3060	1600
3000	121	3160	1650
3100	125	3260	1700
3200	129	3360	1750

Design and Function

Safety information

The device must be operated only at low protective voltage where there is safe electrical isolation. Modifications and repairs must be carried out only by your supplier!

The system must be maintained and inspected on a regular basis.

A soft, clean cloth may be used to clean the system. Do not use any aggressive or abrasive cleaning agents that will corrode the surfaces. The device must not be subjected to severe impacts or vibrations.

Commissioning

Prerequisites

- The transmitter unit and receiver unit have been mounted and aligned correctly.
- The electrical connection has been established as per the information in the connection diagram.
- The signal output responds to object measurement.
- If at least one beam of light is interrupted, the output remains active for as long as the object is detected.

Troubleshooting

- Measure operating voltage
- Check cabling.
- Check transmitter and receiver unit for dirt. Clean if necessary.

Function indicators

A green LED for indicating the operating status "Power ON" and a yellow status indication LED are fitted on the connection side of the profiles, behind the lens cover.

Transmitter Unit

Function	Description of Diagnosis
Green LED to display operating status permanently illuminated	Power On
Green LED to display operating status is not illuminated. Yellow LED to indicate status is flashing	Energy-saving mode
Yellow LED to indicate status is not illuminated	Transmission power of transmitter is low
Yellow LED to indicate status is permanently illuminated	Transmission power of transmitter is high
Yellow LED to indicate status is flashing rapidly (approx. 8 Hz)	Fault state
Yellow LED to indicate status — brief change in light emitted	Test input is activated

Receiver Unit

Function	Description of Diagnosis
Green LED to display operating status permanently illuminated	Power On
Green LED to display operating status is not illuminated	Energy-saving mode
Green LED to display operating status is flashing at brief intervals	IO-Link mode active. Possible to parameterize the device only via IO-Link
Green LED to display operating status is flashing (4 Hz)	Fault status: short circuit at the outputs
Yellow LED to indicate status is permanently illuminated	Detection field interrupted
Yellow LED to indicate status is not illuminated	Detection field is clear.
Yellow LED to indicate status is flashing (approx. 4 Hz)	Insufficient stability control
Yellow LED to indicate status is flashing rapidly (approx. 8 Hz)	Fault state: fault during signal measurement

Resolution and Beam Gap

The optical resolution of the light grid corresponds to the size of the object that can be detected.

The values specified in the technical data under "Optical Resolution" apply if signal tracking for the threshold value is activated. Where the system is parameterized via the touch field menu (level 2, "Signal Tracking"), the value is automatically set to 60%. It is not possible to set other values. To parameterize the system via IO-Link, a threshold value of at least 60% must be entered. Signal tracking for the threshold value is deactivated by default, increasing the optical resolution by a maximum of 4 mm. By selecting 3-way crossover of the light beams, the resolution of the light grid is refined.

The switching outputs respond to any instance in which the beam is interrupted by an object. Selective object detection can also be parameterized using predefined or taught-in objects. Up to 2 beam areas can be suppressed (blanking).

The devices are supplied without object detection programmed, with signal tracking of the threshold value deactivated, and with a beam path with a 3-way crossover.

Resolution of the Crossed Beam Arrangement

If 3-way beam crossover is programmed, the resolution is refined. In the case of 3-way crossover, this means that the increased resolution is offered once 25% of the transmitter unit range or receiver unit range has been covered. It is therefore necessary to ensure that all objects pass the transmitter or receiver with such a gap.

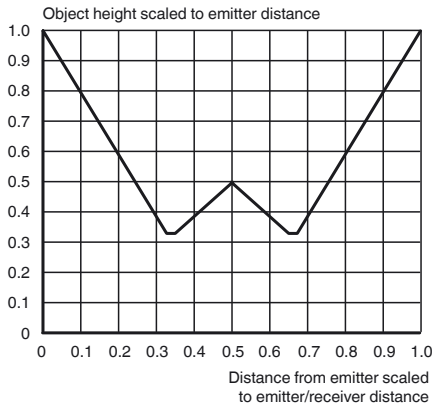

IO-Link

The sensor parameters are device-specific and are described in the standardized IO Device Description file (IODD). The IODD can be read into different engineering tools using IODD support from different system providers. The sensor can then be configured or diagnosed using the relevant tool and a user interface generated from the IODD.

The IODD interpreter are available in the corresponding product description on our homepage, www.pepperl-fuchs.com. For the IODD description contact the P+F support.

Model number

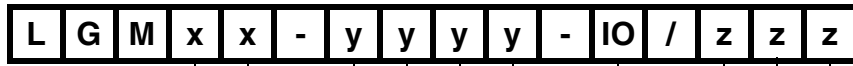

Resolution [mm]
(see technical data)

Detection field [mm]
(see technical data)

IO-Link interface

Options

- /110 Push-pull output, switch output 0.1 A, short-circuit protected, reverse polarity protection
- /115b with 0.2 m fixed cable and M12 connector

Release date: 2017-07-20 10:26 Date of issue: 2017-07-20 251333_eng.xml

Refer to "General Notes Relating to Pepperl+Fuchs Product Information".

Pepperl+Fuchs Group
www.pepperl-fuchs.com

USA: +1 330 486 0001
fa-info@us.pepperl-fuchs.com

Germany: +49 621 776 4411
fa-info@de.pepperl-fuchs.com

Singapore: +65 6779 9091
fa-info@sg.pepperl-fuchs.com